

御納入先

殿

殿

製品納入仕様書

工事件名
(現場名)

貴注文番号等

品名

埋設管標示ピン「キッツアイ」

型式 / 仕様

別紙図に記す形状寸法、および各種任意の標示内容に基づく

ご受領日	
ご受領印	

出図年月日

整理番号等

販売

〒530-0053 大阪市北区末広町2番38号



株式
会社

石井マーク

電話：06-6314-1410 FAX：06-6314-2502



図 番

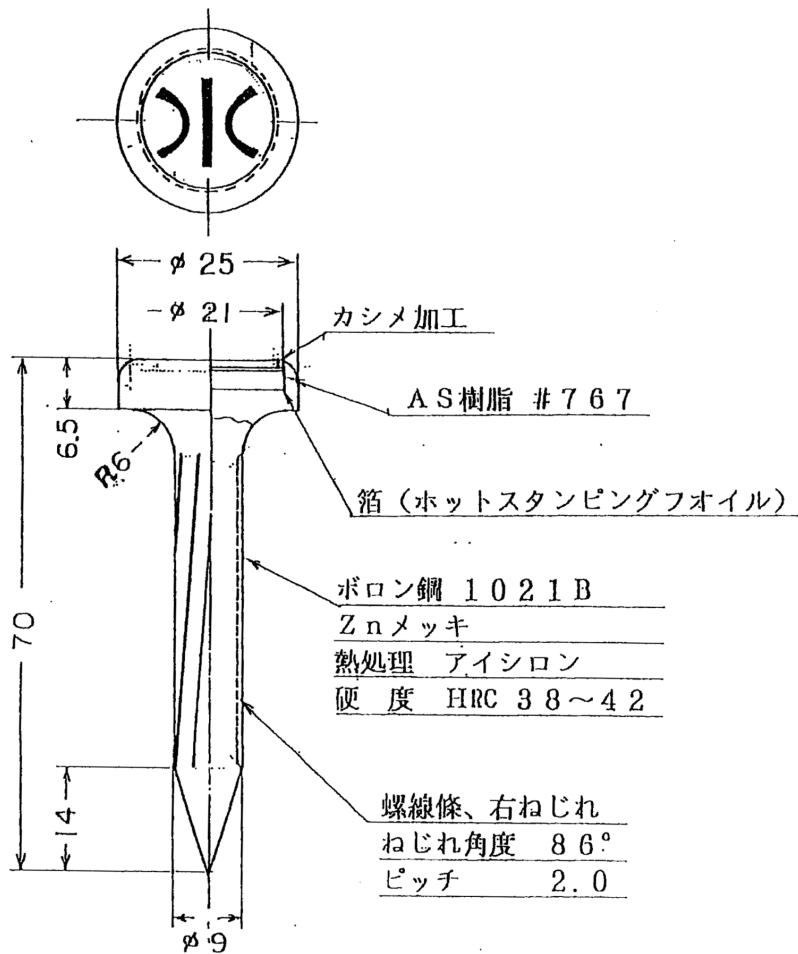



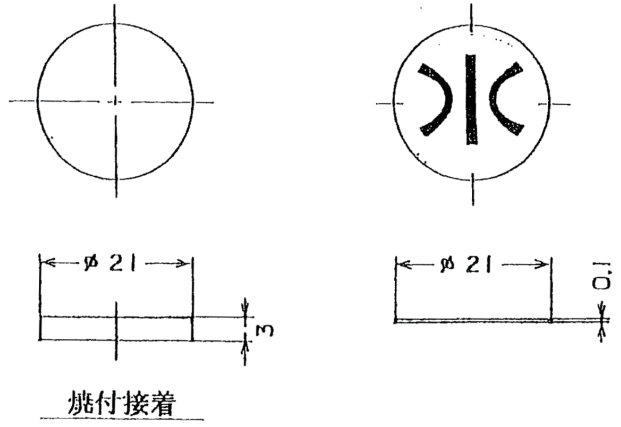







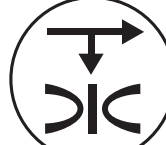









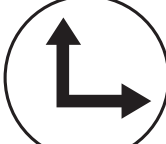
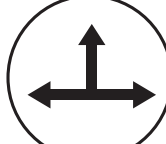

例 標 示 マ - 2

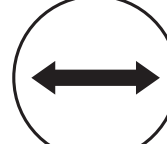
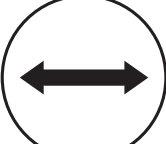
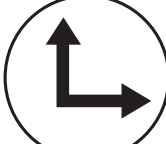
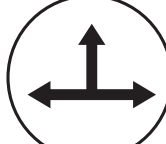
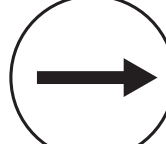

製品名		管理設標示ピン		
部番		部品名		
材料		個数		
検図	設計	製図	写図	製図日附
				2004. 4. 1
株式会社 イリエ製作所				

標示内容の例を示す図

下地	文字・矢印	(水道・給水用)
青地	黒	     W-1 W-2 W-3 W-4 W-5
黄地	黒	<p>(ガス用)</p>      G-1Y G-2Y G-3Y G-4Y G-5Y
赤地	黒	<p>(消火配管用)</p>      S-1 S-2 S-3 S-4 S-5
白地	赤色	<p>(電力用)</p>      E-1A E-2 E-3 E-4 E-5A
白地	黄色	<p>(通信用)</p>      IT-1 IT-2 IT-3 IT-4 IT-5
茶地	黒色	<p>(油送管ほか油用)</p>      O-1 O-2 O-3 O-4 O-5

(図は表記品番の一例であり、必要に応じてその他の色や文字・矢印を用いて任意に記すものとする。)